

TOSHIBA BIPOLAR LINEAR INTEGRATED CIRCUIT SILICON MONOLITHIC

TA7343AP**FM PLL MPX**

The TA7343AP is PLL FM stereo multiplex IC.
It is suitable for automotive applications and portable radio applications because of space merit by the package and wide supply voltage range.

FEATURES

- Excellent stereo LED sensitivity
: $V_L(ON) = 9mV_{rms}$ (Typ.)
- Suitable for LED driving : $I_{LED} = 20mA$ (Max.)
- Recommendable input voltage range
: $V_{in} = 200\sim 700mV_{rms}$
- Operating supply voltage range : $V_{CC} = 3.5\sim 12V$
- Excellent channel separation through entire audio frequency range : $Sep = 45dB$ (Typ.)
- Low distortion : $THD = 0.08\%$ (Typ.) at $V_{in} = 200mV_{rms}$ (Stereo)
- Built-in compulsive monaural function. (The VCO is stopped when the pin⑦ is connected with the power supply line, and then the stereo indicator is turn off.)
- Easy adjustment (The monitored free running frequency of VCO is 38kHz at pin⑥.)

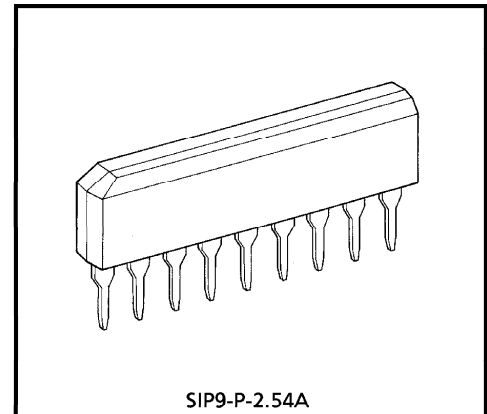

SIP9-P-2.54A
Weight : 0.92g (Typ.)

961001EBA2

- TOSHIBA is continually working to improve the quality and the reliability of its products. Nevertheless, semiconductor devices in general can malfunction or fail due to their inherent electrical sensitivity and vulnerability to physical stress. It is the responsibility of the buyer, when utilizing TOSHIBA products, to observe standards of safety, and to avoid situations in which a malfunction or failure of a TOSHIBA product could cause loss of human life, bodily injury or damage to property. In developing your designs, please ensure that TOSHIBA products are used within specified operating ranges as set forth in the most recent products specifications. Also, please keep in mind the precautions and conditions set forth in the TOSHIBA Semiconductor Reliability Handbook.
- The products described in this document are subject to foreign exchange and foreign trade control laws.
- The information contained herein is presented only as a guide for the applications of our products. No responsibility is assumed by TOSHIBA CORPORATION for any infringements of intellectual property or other rights of the third parties which may result from its use. No license is granted by implication or otherwise under any intellectual property or other rights of TOSHIBA CORPORATION or others.
- The information contained herein is subject to change without notice.

BLOCK DIAGRAM

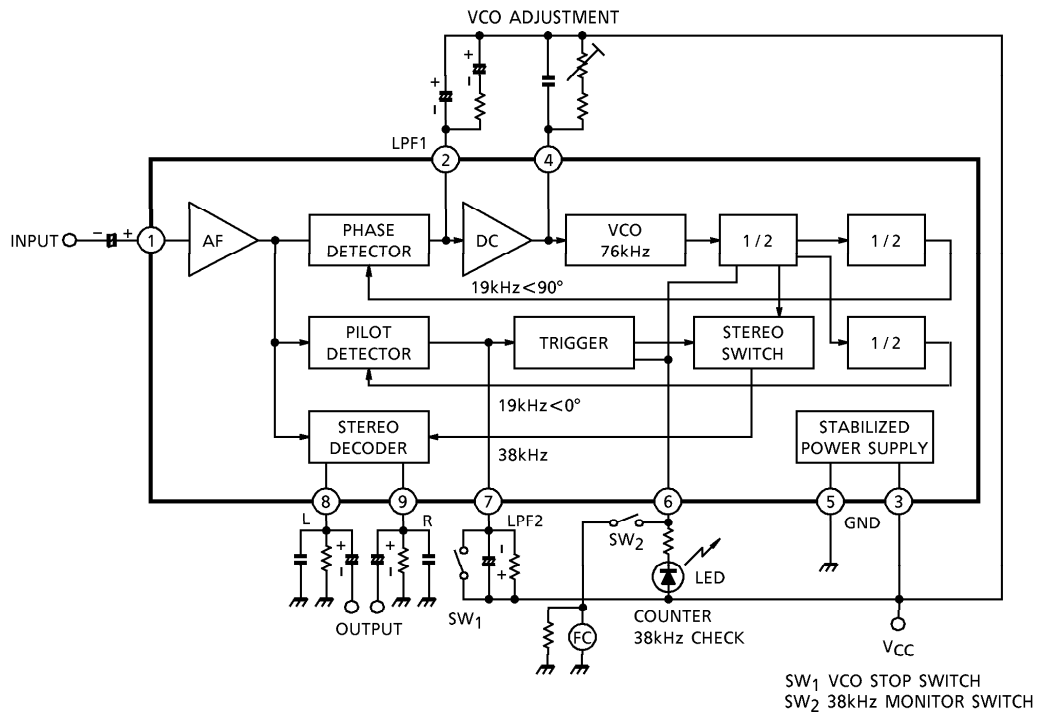

MAXIMUM RATINGS (Ta = 25°C)

| CHARACTERISTIC | SYMBOL | RATING | UNIT |
|-----------------------|-----------------------|---------|------|
| Supply Voltage | V _{CC} | 12 | V |
| LED Voltage | V _{LED} | 16 | V |
| LED Current | I _{LED} | 20 | mA |
| Power Dissipation | P _D (Note) | 500 | mW |
| Operating Temperature | T _{opr} | -30~75 | °C |
| Storage Temperature | T _{stg} | -55~155 | °C |

(Note) Derated above Ta = 25°C in the proportion of 4mW/°C.

ELECTRICAL CHARACTERISTICS

1. DC characteristics (Ta = 25°C, V_{CC} = 8V, terminal voltage at no signal)

| PIN No. | CHARACTERISTIC | SYMBOL | TYP. | UNIT |
|---------|-----------------|--------|------|------|
| Pin① | INPUT | V1 | 3.5 | V |
| Pin② | LPF 1 | V2 | 6.6 | V |
| Pin③ | V _{CC} | V3 | 8.0 | V |
| Pin④ | VCO | V4 | 7.1 | V |
| Pin⑤ | GND | V5 | 0 | V |
| Pin⑥ | ST LED | V6 | — | V |
| Pin⑦ | LPF 2 | V7 | 7.4 | V |
| Pin⑧ | L-ch OUTPUT | V8 | 4.0 | V |
| Pin⑨ | R-ch OUTPUT | V9 | 4.0 | V |

2. AC characteristics (Unless otherwise specified, $T_a = 25^\circ\text{C}$, $V_{CC} = 8\text{V}$, $f = 1\text{kHz}$)

| CHARACTERISTIC | | SYMBOL | TEST CIRCUIT | TEST CONDITION | MIN. | TYP. | MAX. | UNIT | |
|-------------------------------------|----------|-----------------------|--------------|--|------------------------|---------|------|------------|----|
| Supply Current | | I_{CC} | — | at LED off | — | 11 | 18 | mA | |
| Input Resistance | | R_{IN} | — | | — | 33 | — | $k\Omega$ | |
| Max. Composite Signal Input Voltage | | V_{in} MAX (STEREO) | — | L + R = 90%, P = 10% THD = 1% | — | 900 | — | mV_{rms} | |
| Separation | | Sep | — | L + R = 180 mV_{rms} P = 20 mV_{rms} | 36 | 45 | — | dB | |
| Total Harmonic Distortion | Monaural | THD (MONAURAL) | — | $V_{in} = 200mV_{rms}$ | — | 0.08 | 0.3 | % | |
| | Stereo | THD (STEREO) | — | L + R = 180 mV_{rms} P = 20 mV_{rms} | — | 0.08 | — | | |
| Voltage Gain | | G_V | — | $V_{in} = 200mV_{rms}$ | -2.0 | 0 | 2.0 | dB | |
| Channel Balance | | CB | — | $V_{in} = 200mV_{rms}$ | — | 0 | 1.5 | dB | |
| Stereo LED Sensitivity | ON | V_L (ON) | — | Pilot Input | — | 9 | 15 | mV_{rms} | |
| | OFF | V_L (OFF) | — | | 2 | 6 | — | | |
| Stereo LED Hysteresis | | V_H | — | to turn off from LED turn on | — | 3 | — | mV_{rms} | |
| Capture Range | | CR | — | P = 20 mV_{rms} | — | ± 3 | — | % | |
| Carrier Leak | 19kHz | CL | — | P = 20 mV_{rms} L + R = 180 mV_{rms} | — | 34 | — | dB | |
| | 38kHz | | | | — | 42 | — | | |
| SCA Rejection Ratio | | SCA Rej | — | P = 20 mV_{rms} L + R = 160 mV_{rms} SCA = 20 mV_{rms} $f_{SCA} = 67\text{kHz}$ | — | 70 | — | dB | |
| Signal to Noise Ratio | | S / N | — | $V_{in} = 200mV_{rms}$ $f = 1\text{kHz}$, $R_g = 620\Omega$ | — | 74 | — | dB | |
| Output Current (Pin⑧, Pin⑨) | | I_{OUT} | — | $R_L = 3.3k\Omega$ | $V_{CC} = 3.5\text{V}$ | — | 0.3 | 0.6 | mA |
| | | | | | $V_{CC} = 8.0\text{V}$ | — | 1.2 | 1.8 | |
| | | | | | $V_{CC} = 12\text{V}$ | — | 1.4 | 2.1 | |

TEST CIRCUIT

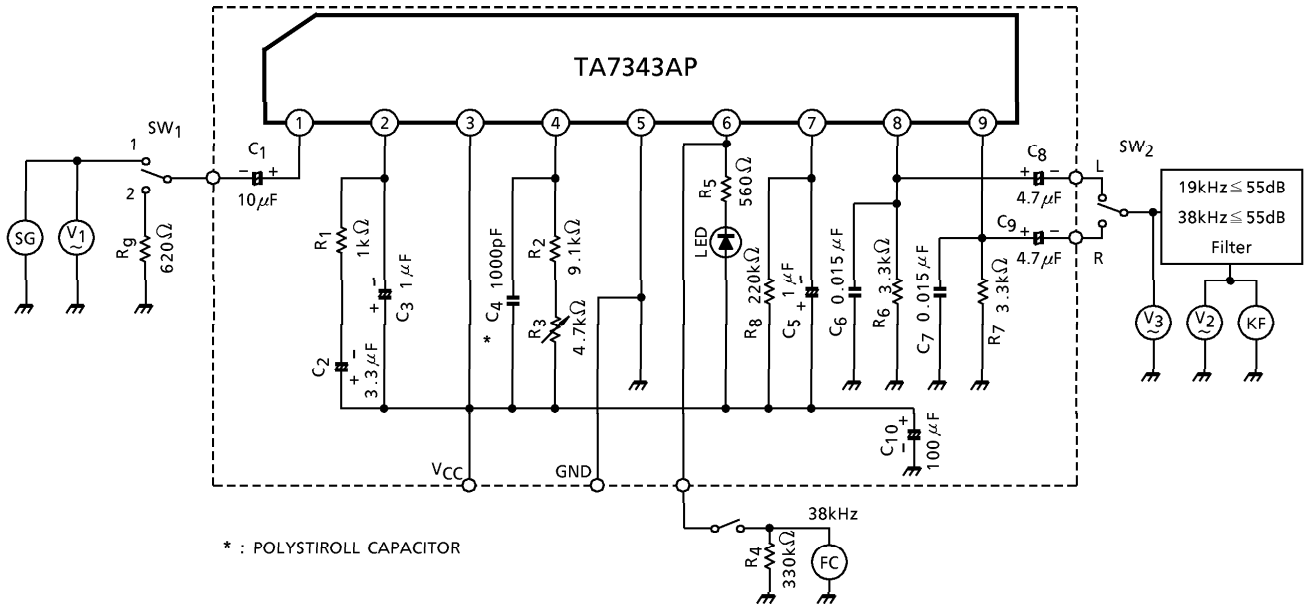

- SG : STEREO SIGNAL GENERATOR
- FC : FREQUENCY COUNTER
- V₁, V₂, V₃ : AC VOLTMETER
- KF : DISTORTION METER

EXTERNAL PARTS TABLE

| PARTS No. | TYPICAL | PURPOSE | INFLUENCE | | NOTE |
|----------------|------------------|----------------------------|--|------------------------------------|---|
| | | | SMALLER THAN TYP. | GREATER THAN TYP. | |
| C ₁ | 10 μ F | Coupling | Separation is bad at 50~300Hz | "POP" noise is high | Input |
| C ₂ | 3.3 μ F | LPF at PLL | THD is bad at 5~10kHz (stereo) | Narrow capture range | — |
| C ₃ | 1 μ F | | | | |
| R ₁ | 1k Ω | | | | |
| C ₄ | 1000pF | VCO Free Running | C ₄ : Small→Wide capture range and large glitter C ₄ : Large→Narrow capture range | — | — |
| R ₂ | 9.1k Ω | Frequency adjustment | | | |
| R ₃ | 4.7k Ω VR | | | | |
| R ₄ | 330k Ω | Monitor Load | — | — | — |
| R ₅ | 560 Ω | Rush Current Limiter | IC is damaged by the rush current | LED is dark | I _{LED} \leq 20mA |
| LED | — | Stereo Indicator | Usable for LED | | |
| C ₆ | 0.015 μ F | Load and Diemphasis | Diemphasis (50 μ s) | | C ₆ = 0.022 μ F for 75 μ s |
| R ₆ | 3.3k Ω | | Output voltage is small | THD is bad for low V _{CC} | |
| C ₇ | 0.015 μ F | Load and Diemphasis | Diemphasis (50 μ s) | | C ₇ = 0.022 μ F for 75 μ s |
| R ₇ | 3.3k Ω | | Output voltage is small | THD is bad for low V _{CC} | |
| C ₈ | 4.7 μ F | Output Coupling | Frequency response is bad | "POP" noise is large | L-ch |
| C ₉ | 4.7 μ F | Output Coupling | | | R-ch |
| R ₈ | 220k Ω | LED Sensitivity Adjustment | V _L (ON) is large | V _L (ON) is small | — |
| C ₅ | 1 μ F | LPF at LED | THD is bad at 50~300Hz | Slow LED response | — |

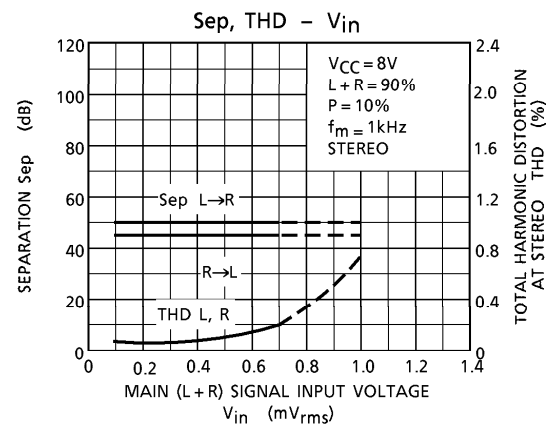
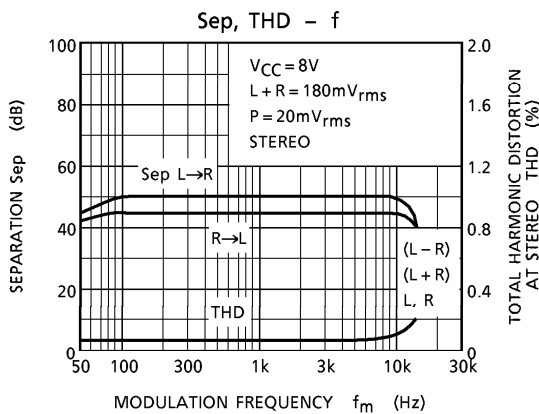
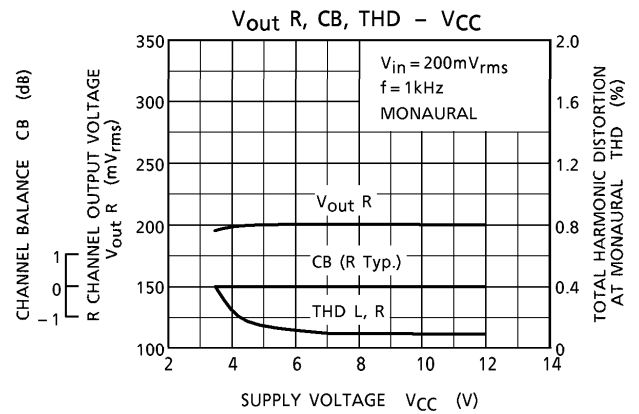
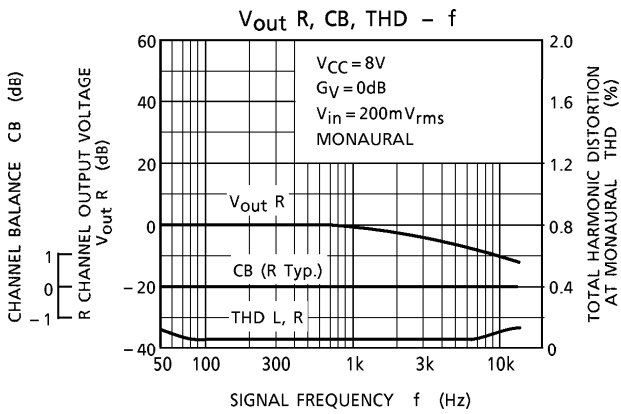
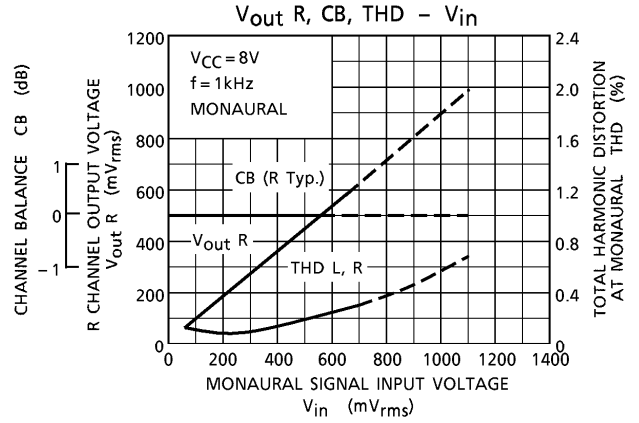
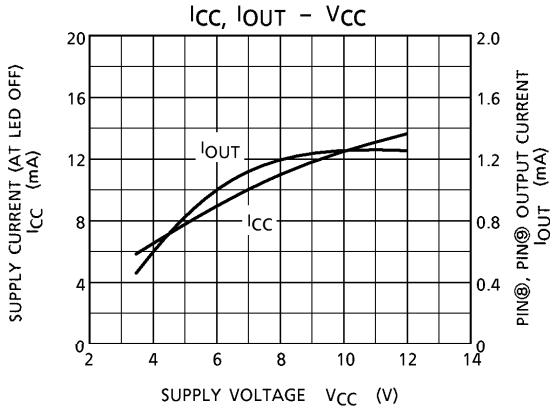

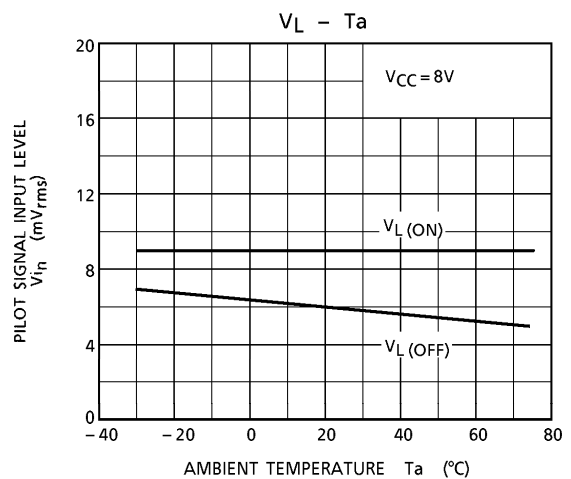
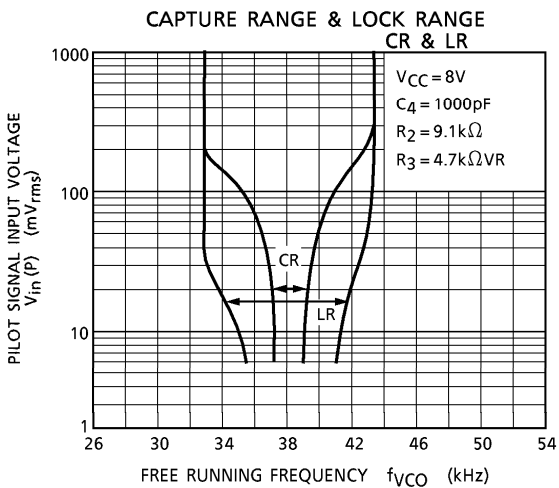
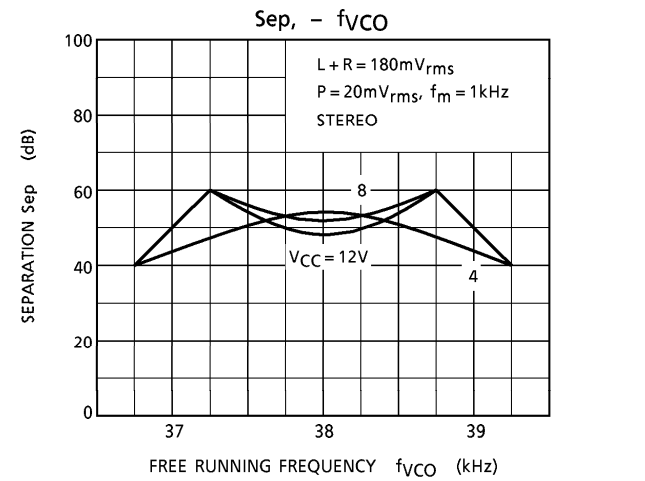
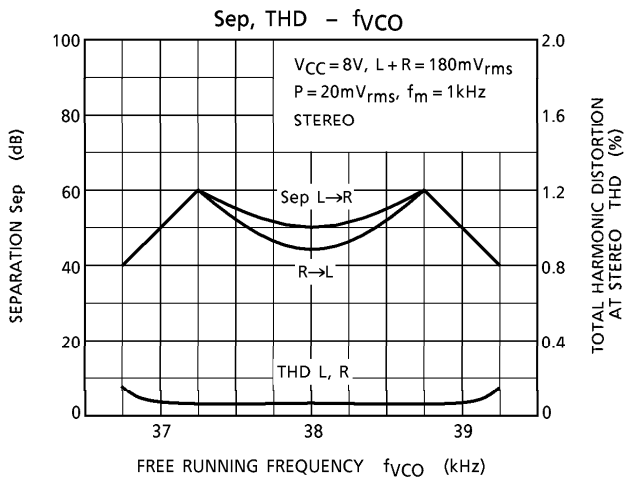
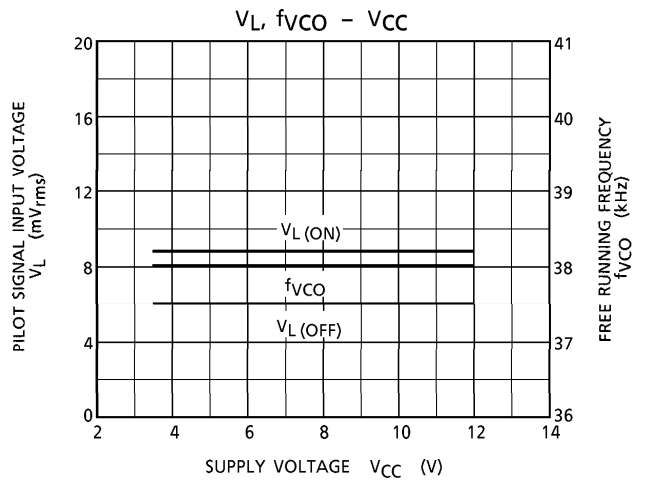
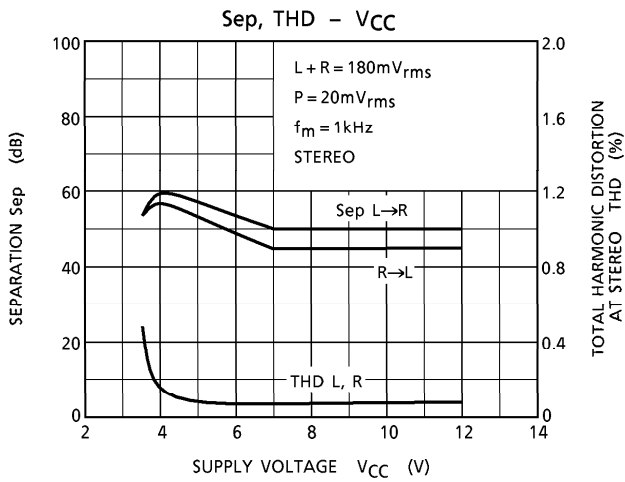

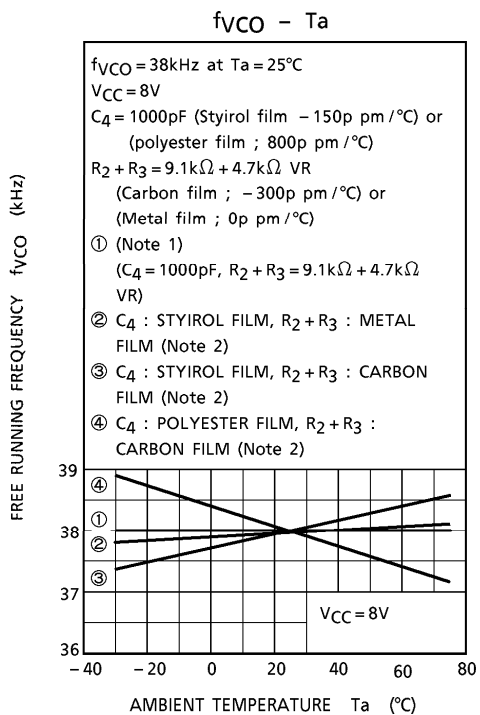
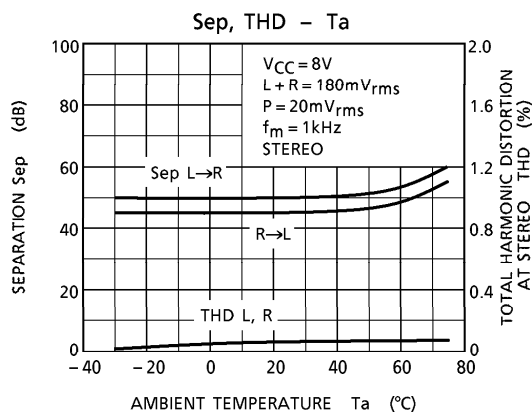
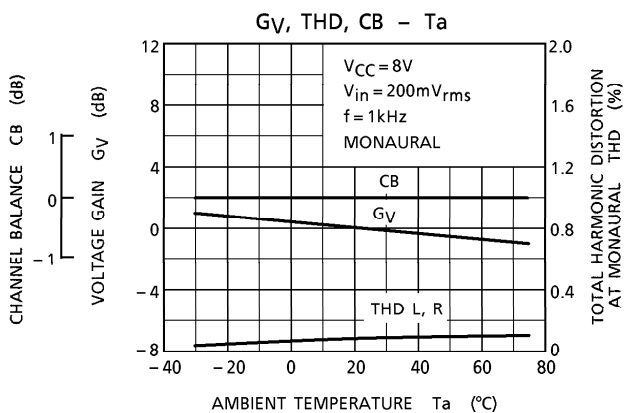

(Note 1) ① : With IC only put into a temperature test chamber

(Note 2) ②③④ : With IC, resistors and capacitors put into a temperature test chamber

OUTLINE DRAWING
SIP9-P-2.54A

Unit : mm

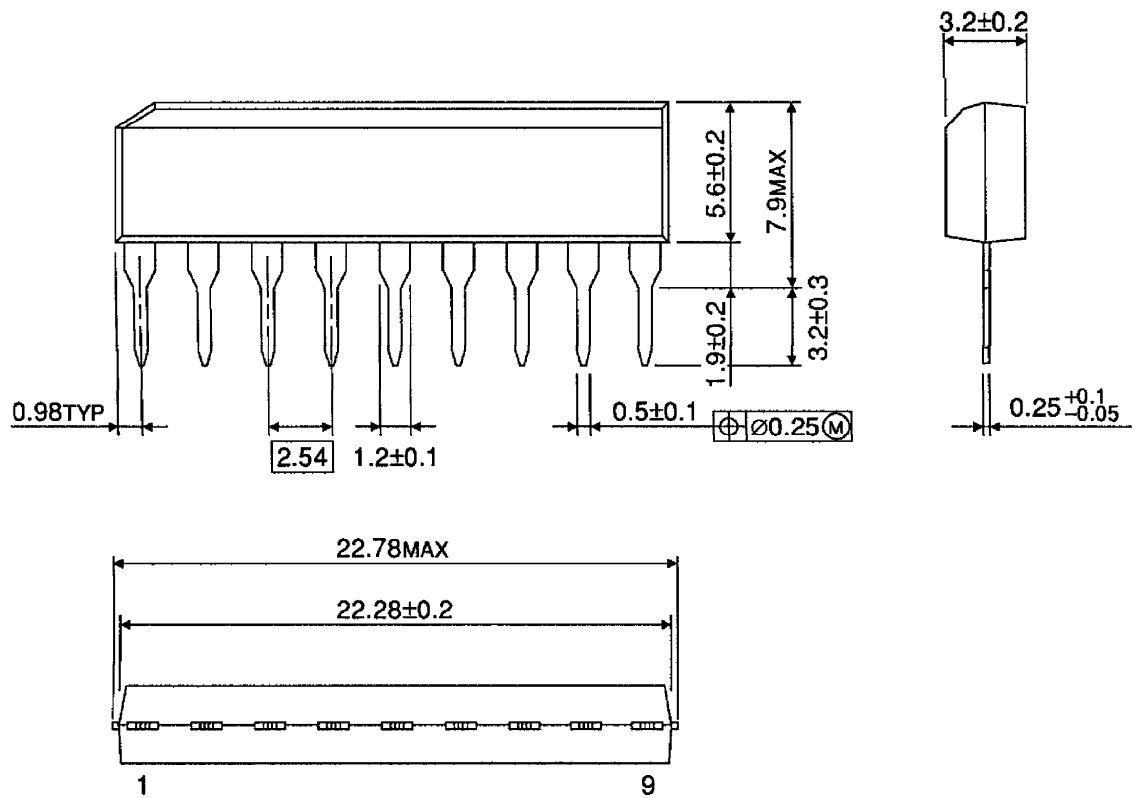

Weight : 0.92g (Typ.)